

Barrier type terminal block

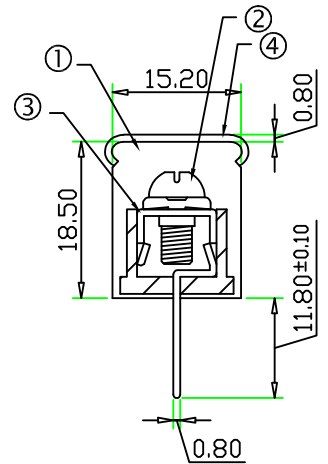
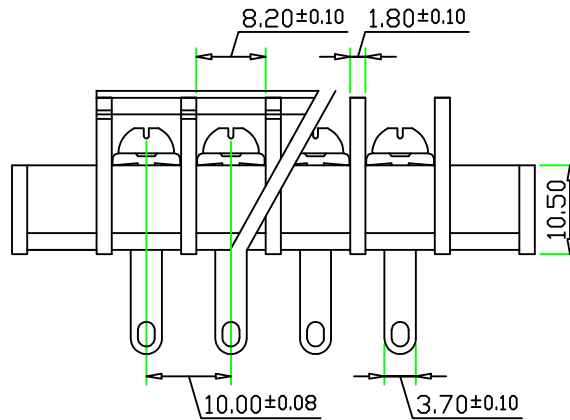
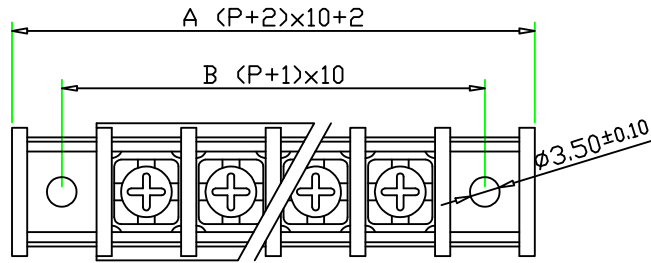

Part Number:

HD-108-PH-

C: With Cover

Pole Size 2~30P

SPECIFICATIONS

- ① Housing Material: Polyamide 66(UL94V-0), Black
- ② Screw: M3.5 Nickel Plated Steel
- ③ Terminals: Tin Plated Brass
- ④ Cover: PC Transparent

Screws Torque: 7 In-Lb

Wire Range: 14~18 AWG

Rated: 15 Amperes.AC250V

Operation Temperature: -55°C~+95°C

Insulation withstands volt: AC2000V min

Insulation resistance: >1000MΩ or more at DC500V