

**SCOPE:** This specification applies to – CIMXX5M1 - Header

**SPECIFICATIONS:**

Number of poles: 2 – 25  
 Sides configuration: Modular  
 Pitch: 5.0 mm  
 Voltage: 300V  
 Current: 15A  
 Wire section: 0.05 - 2.5 mm<sup>2</sup>  
 Available approvals: UL, CSA, VDE, IMQ



Insertion force per pole: max. 3 N  
 Withdrawal force per pole: min. 1,5 N  
 PCB thickness: max. 2.4 mm  
 Operating temperature range: - 40°C to +105°C  
 Contact resistance: <15 mOhm  
 Insulation resistance: >1 GOhm

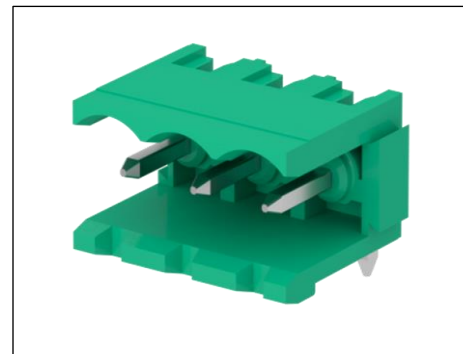

Terminal contact: Nickel and tin on copper alloy  
 Insulating housing material: PA polyamide  
 Color: Green (Standard)

**DIMENSIONS:**

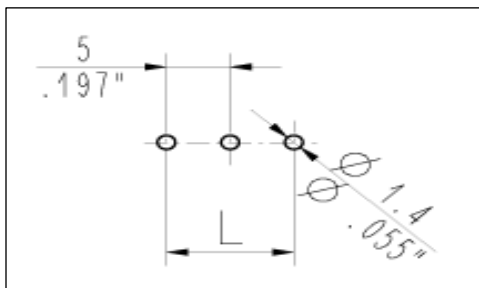
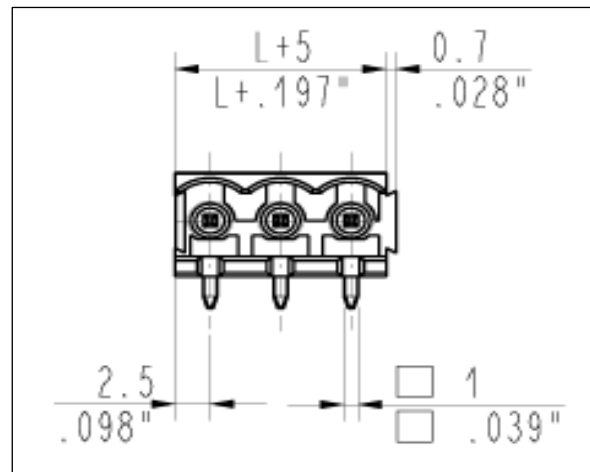
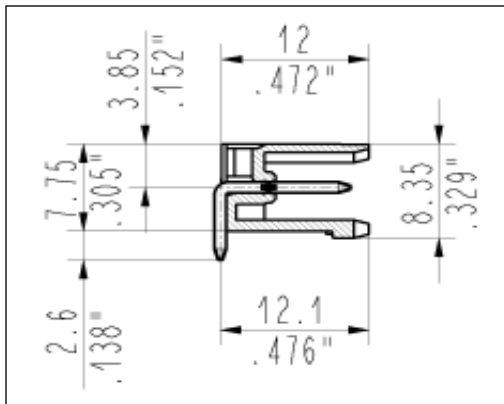

**Mates with:**  
 CIF series  
 CVF series  
 CCF series

<p><b>BlockMaster</b>                  Confidential and                  Proprietary</p>	<p><b>BlockMaster Electronics</b>                  1400 Howard Street                  Elk Grove Village, IL. 60007                  Toll Free: 800-595-8881 FAX: 847-956-1690  <a href="http://www.blockmaster.com">www.blockmaster.com</a></p>
<p>All dimensions are in MM unless otherwise specified</p>	
<p>Drawing Number:                  CIMXX5M1</p>	<p><b>Header</b></p>
<p>Date:                  6/11/2017</p>	<p>THE INFORMATION DISCLOSED HEREIN WAS ORIGINATED BY AND IS THE PROPERTY OF BLOCKMASTER ELECTRONICS INC. AND EXCEPT FOR USE EXPRESSLY GRANTED TO THE UNITED STATES GOVERNMENT BLOCKMASTER ELECTRONICS INC. RESERVES ALL PATENT PROPRIETARY DESIGN, USE, SALE, MANUFACTURING AND PRODUCTION RIGHTS THERETO. THIS DOES NOT APPLY TO VENDOR.</p>