

SCOPE: This specification applies to – MSMXX042 – Terminal Block

SPECIFICATIONS:

Number of poles: 1 – 6
 Sides configuration: 35° Modular
 Pitch: 10 mm
 Voltage: 600 V
 Current: 17.5 A
 Wire section: 0.05 - 1.5 mm² / 30 - 12 AWG
 Available approvals: UL, VDE, IMQ, CSA



Screw dimensions: M3
 Recommended Tightening Torque: 0.5 Nm
 PCB thickness: max. 2.4 mm
 PBC hole diameter: 1.4 mm
 Stripping length: 6.5 mm
 Operating temperature range: -40°C to + 105°C
 Contact resistance: <15 mOhm
 Insulation resistance: >1 GOhm

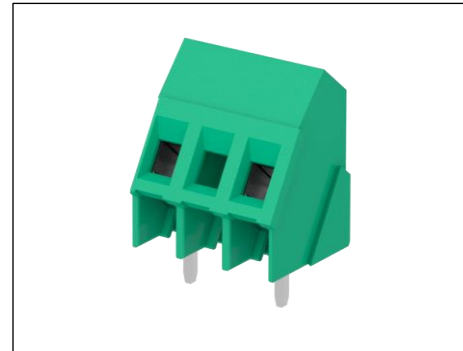

Screw material: Nickel-plated copper alloy
 Terminal contact: Nickel and tin on copper alloy
 Clamp tightening: Nickel-plated copper alloy
 Insulating housing material: PA polyamide
 Color: Green (Standard)

DIMENSIONS:

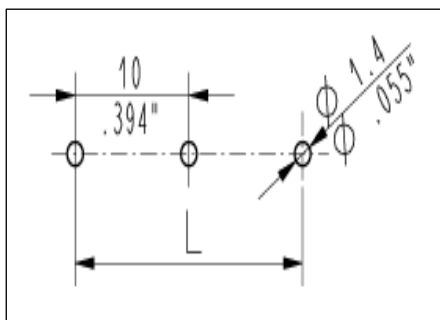
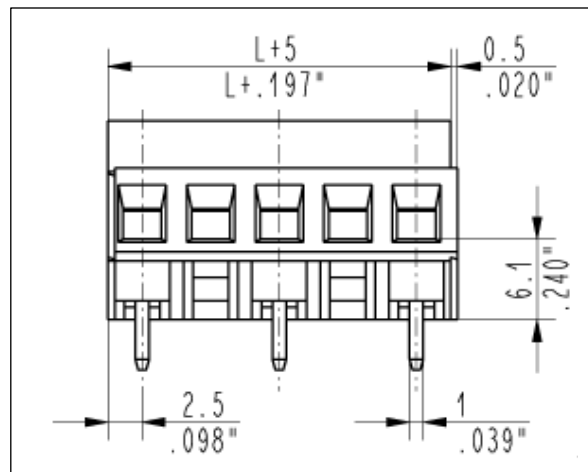
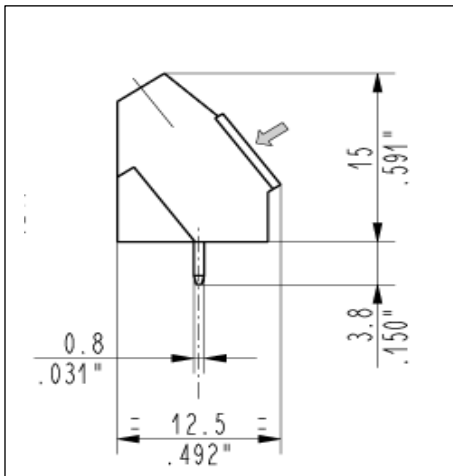

<p>BlockMaster Confidential and Proprietary</p>	<p>BlockMaster Electronics 1400 Howard Street Elk Grove Village, IL. 60007 Toll Free: 800-595-8881 FAX: 847-956-1690 www.blockmaster.com</p>
<p>All dimensions are in MM unless otherwise specified</p>	
<p>Drawing Number: MSMXX042</p>	<p>Terminal Block</p>
<p>Date: 6/11/2017</p>	<p>THE INFORMATION DISCLOSED HEREIN WAS ORIGINATED BY AND IS THE PROPERTY OF BLOCKMASTER ELECTRONICS INC. AND EXCEPT FOR USE EXPRESSLY GRANTED TO THE UNITED STATES GOVERNMENT BLOCKMASTER ELECTRONICS INC. RESERVES ALL PATENT PROPRIETARY DESIGN, USE, SALE, MANUFACTURING AND PRODUCTION RIGHTS THERETO. THIS DOES NOT APPLY TO VENDOR.</p>