

SCOPE: This specification applies to – CIMXX9A5 - Header



SPECIFICATIONS:

Number of poles: 2 – 25
 Sides configuration: 90° Side stackable
 Pitch: 5.08 mm
 Voltage: 300V
 Current: 15A
 Wire section: 0.05 - 2.5 mm²
 Available approvals: UL, VDE, IMQ, CSA

Insertion force per pole: max. 3 N
 Withdrawal force per pole: min. 1,5 N
 PCB thickness: max. 2.4 mm
 Operating temperature range: - 40°C to +105°C
 Contact resistance: <15 mOhm
 Insulation resistance: >1 GOhm

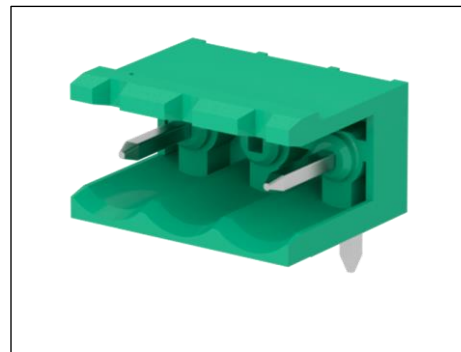

Terminal contact: Nickel and tin on copper alloy
 Insulating housing material: PA polyamide
 Color: Green (Standard)

DIMENSIONS:

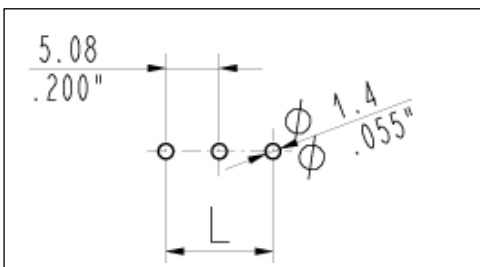
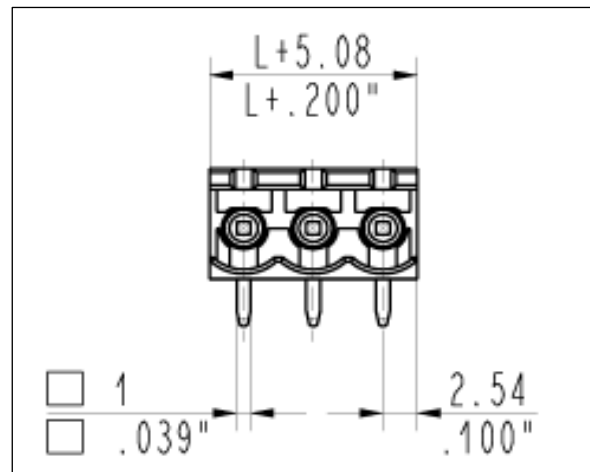
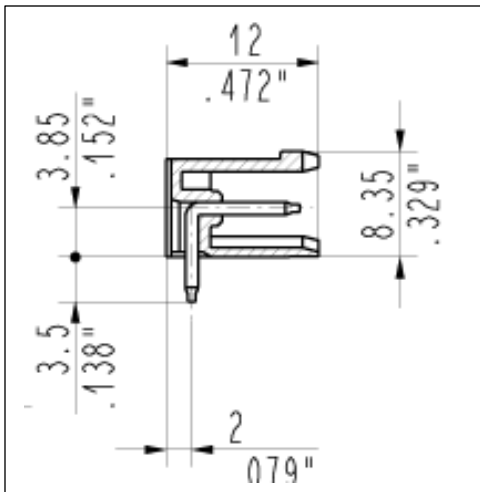

Mates with:
CIF series
CVF series
CCF series

<p>BlockMaster Confidential and Proprietary</p>	<p>BlockMaster Electronics 1400 Howard Street Elk Grove Village, IL. 60007 Toll Free: 800-595-8881 FAX: 847-956-1690 www.blockmaster.com</p>
<p>All dimensions are in MM unless otherwise specified</p>	
<p>Drawing Number: CIMXX9A5</p>	<p>Header</p>
<p>Date: 6/11/2017</p>	<p>THE INFORMATION DISCLOSED HEREIN WAS ORIGINATED BY AND IS THE PROPERTY OF BLOCKMASTER ELECTRONICS INC. AND EXCEPT FOR USE EXPRESSLY GRANTED TO THE UNITED STATES GOVERNMENT BLOCKMASTER ELECTRONICS INC. RESERVES ALL PATENT PROPRIETARY DESIGN, USE, SALE, MANUFACTURING AND PRODUCTION RIGHTS THERETO. THIS DOES NOT APPLY TO VENDOR.</p>