

**SCOPE:** This specification applies to – PSBXX0M5 – Terminal Block

**SPECIFICATIONS:**

Number of poles: 2 - 13  
 Side configuration: Modular, medium tower  
 Pitch: 5.08 mm  
 Voltage: 300 V  
 Current: 13.5 A  
 Wire section: 0.05 - 1.5 mm<sup>2</sup> / 30 – 15 AWG  
 Available approvals: UL, VDE, IMQ, CSA

Screw dimensions: M3  
 Recommended Tightening torque: 0.7 Nm  
 Stripping length: 6.0 mm  
 PCB thickness max. 2.4 mm  
 PCB hole diameter min. 1.2 mm  
 Operating temperature range: -40°C to +105°C  
 Contact resistance: <15 mOhm  
 Insulation resistance: >1 GOhm

Screw material: Nickel-plated copper alloy  
 Terminal contact: Nickel and tin on copper alloy  
 Clamp tightening: Nickel-plated copper alloy  
 Insulating housing material: PA polyamide  
 Color: Green (Standard)

**DIMENSIONS:**

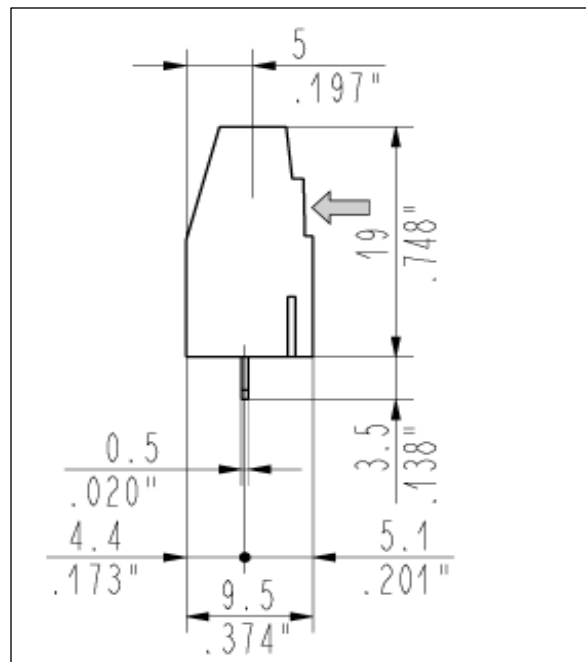
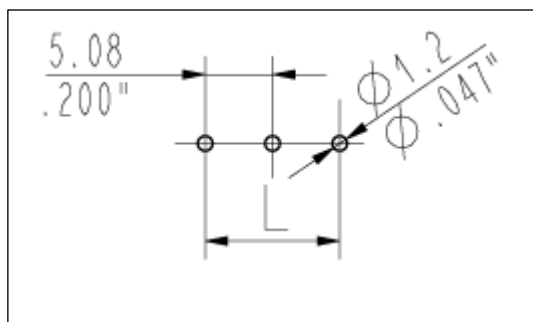
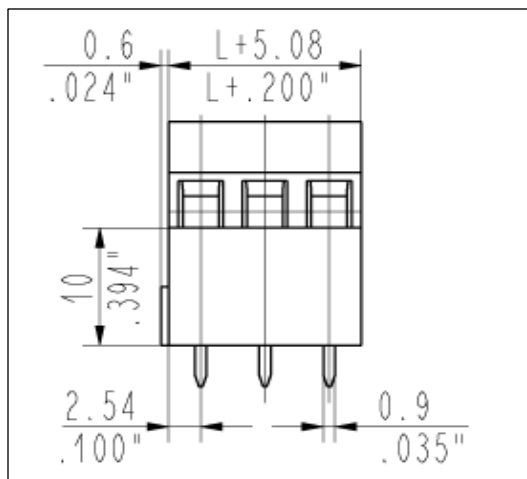

<p><b>BlockMaster</b>                  Confidential and                  Proprietary</p>	<p><b>BlockMaster Electronics</b>                  1400 Howard Street                  Elk Grove Village, IL. 60007                  Toll Free: 800-595-8881 FAX: 847-956-1690  <a href="http://www.blockmaster.com">www.blockmaster.com</a></p>
<p>All dimensions are in MM unless otherwise specified</p>	
<p>Drawing Number:                  PSBXX0M5</p>	<p><b>Terminal Block</b></p>
<p>Date:                  6/11/2017</p>	<p>THE INFORMATION DISCLOSED HEREIN WAS ORIGINATED BY AND IS THE PROPERTY OF BLOCKMASTER ELECTRONICS INC. AND EXCEPT FOR USE EXPRESSLY GRANTED TO THE UNITED STATES GOVERNMENT BLOCKMASTER ELECTRONICS INC. RESERVES ALL PATENT PROPRIETARY DESIGN, USE, SALE, MANUFACTURING AND PRODUCTION RIGHTS THERETO. THIS DOES NOT APPLY TO VENDOR.</p>